

# Distributed IDM-STC versus OFDM-CDD in Two-Hop Relay-Networks

Petra Weitkemper\*, Sebastian Vorköper†, Dirk Wübben\*, Karl-Dirk Kammeyer\*, Volker Kühn†

\*Dept. of Communications Engineering, University of Bremen, 28359 Bremen, Germany

† Institute of Telecommunications, University of Rostock, 18119 Rostock, Germany

Email: weitkemper@ant.uni-bremen.de

**Abstract**—This paper investigates the performance of two diversity techniques for relay networks with the Amplify-Forward (AF) protocol. A distributed Interleave-Division-Multiplexing Space-Time Code (IDM-STC) is compared with Cyclic Delay Diversity (CDD) in an OFDM based system. The aim of this paper is to figure out advantages and drawbacks of these two quite different approaches for various scenarios. It is shown that IDM-STC is superior for non-frequency-selective channels but OFDM-CDD improves compared to IDM-STC for increasing channel memory, especially for stronger codes.

## I. INTRODUCTION

Distributed relay systems have attracted much attention in the last years. Several relays assisting a source to transmit data to a destination build up a virtual MIMO (VMIMO) system where the relays are combined to a virtual antenna array (VAA). Due to this similarity to classical MIMO systems, diversity techniques known to be powerful for MIMO can be adopted to relay networks. Several approaches to apply Space-Time Codes (STC) in relay networks have been proposed in the last years, however, specific restrictions in relay networks have not been addressed, such as imperfect cooperation and synchronization between the virtual antennas. In [1] and [2], a Space-Time Code based on Interleave Division Multiplexing (IDM-STC) was introduced for a transmitter with multiple antennas. This scheme does not need synchronization or any knowledge about other antennas and is therefore also suitable for relay networks. Each relay applies a relay specific interleaver to forward an estimation of the received signal. At the destination these signals can be separated by an iterative detector similar to an IDMA receiver [3]. Based on this idea, an IDM-STC was applied to relay networks in [4] and [5]. A quite different approach is the application of OFDM in combination with CDD [6]. CDD was shown to be a promising scheme in coded OFDM

based networks with multiple antennas at the transmitter side. It delivers a diversity gain by artificially introducing frequency selective fading, which is exploited by the channel decoder at the receiver. If all relays in this network forward a cyclically shifted version of the OFDM symbols, then the decoder at the destination is capable of utilizing this introduced spatial diversity.

The main difference between the two considered schemes is how the offered spatial diversity is utilized. OFDM with CDD exploits the diversity only by means of channel coding, since the relays' signals superimpose incoherently at the destination, whereas IDM-STC uses Maximum Ratio Combining (MRC) before the channel decoder promising a better performance. However, IDM-STC is limited by the convergence behaviour of the iterative detection, which may be degraded by interference due to additional frequency selectivity of the individual channels. Nevertheless, the spatial diversity can be exploited regardless of the applied channel code. Furthermore, the complexity of the two schemes is another important issue. While the complexity of the OFDM receiver is independent of the channel memory, the iterative detector for IDM-STC has a complexity increasing linearly with the overall channel memory. Although the iterative detector is kept very simple [3], the OFDM approach is more efficient.

The paper is organized as follows: In Section II the system models for IDM-STC and OFDM-CDD are introduced. Simulation results are provided in Section III and conclusions are given in Section IV.

## II. SYSTEM MODEL

A system with one source  $S$ , one destination  $D$  and several parallel relays  $R_\nu$ ,  $1 \leq \nu \leq N$ , as shown in Figure 1 is considered. In the first time slot the source encodes the information bit vector  $\mathbf{d}$  of length  $N_d$  with a channel code  $\mathcal{C}$ . The resulting code bit

vector  $\mathbf{b}$  of length  $N_b$  is mapped on a QPSK symbol vector  $\mathbf{x}_S$  of length  $N_s$  and transmitted to the relays in a broadcast manner. The  $k$ -th element of vector  $\mathbf{x}_S$  is denoted as  $x_S[k]$ . The complex frequency-

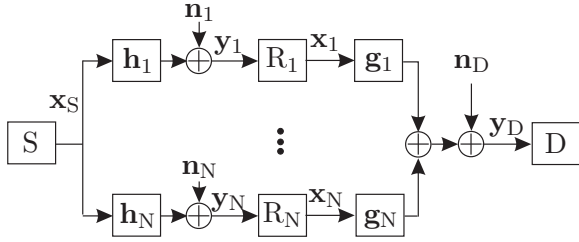

Fig. 1. Block diagram of a relay network with  $N$  parallel relays

selective channel between the source and relay  $R_\nu$  is denoted by  $\mathbf{h}_\nu$  with length  $L_h$  and between relay  $R_\nu$  and the destination by  $\mathbf{g}_\nu$  with length  $L_g$ . The relays receive the source signal convolved with the corresponding channel vector  $\mathbf{h}_\nu$  with  $E\{|\mathbf{h}_\nu|^2\} = 1$  and the additive white Gaussian noise

$$y_\nu[k] = \sum_{l_h=0}^{L_h-1} h_\nu[l_h] x_S[k - l_h] + n_\nu[k]. \quad (1)$$

The average transmit power per station is chosen to  $\sigma_x^2 = 1$ . Furthermore, all relays and the destination experience the same noise variance  $\sigma_N^2$ .

Several relay protocols defining the relay's functionality were proposed. The most common ones are Decode-Forward (DF) and Amplify-Forward (AF) [7]. DF makes use of the discrete alphabet and of the coding gain in a coded system, but suffers from error propagation in the case of wrong decisions at the relay. AF ignores the benefits of channel coding and discrete alphabets, but avoids error propagation and preserves reliability information about the source-relay link. In this paper only AF is considered, as it turns out to be the better choice when several parallel relays are assumed.

Now the question arises, how the relays should transmit their information to the destination. Applying a TDMA scheme would result in a large rate loss which increases with the number of relays. Hence, all relays should transmit at the same time to avoid this rate loss. However, if all relays transmit estimates of the same code bit simultaneously over a flat Rayleigh fading channel and their distances to the destination are nearly the same, the resulting channel would be a flat Rayleigh fading channel as well and no diversity could be gained. A good strategy in terms of performance is given by beamforming, which leads to a constructive superposition of all signal parts at the receiver. However,

it requires channel state information (CSI) at all relays. Distributed space-time block codes show good performance without channel state information but require at least synchronous transmission of all relays. As these requirements are very hard to fulfill in a relay network, we consider two approaches to provide spatial diversity which are known to cope with asynchronism.

#### A. Interleave Division Multiplexing Space-Time Codes

Each relay interleaves the signals to be forwarded with a relay-specific symbol-wise interleaver to avoid a superposition of different copies of the same code bit. In other words, IDMA is applied at the relays to be able to distinguish the signals from different relays at the destination. The interleaved symbol estimates

$$x_\nu[k] = p_\nu y_\nu[\Pi_\nu(k)], \quad k = 1, \dots, N_s \quad (2)$$

are forwarded to the destination in the second time slot with  $\Pi_\nu(\cdot)$  denoting the relay-specific interleaving and the factor  $p_\nu$  normalizes the relays' transmit power to 1. The received signal at the destination consists of the superposition of all relays' signals convolved with the corresponding channel vector and is given by

$$y_D[k] = \sum_{\nu=1}^N \sum_{l_g=0}^{L_g-1} g_\nu[l_g] x_\nu[k - l_g] + n_D[k] \quad (3)$$

where  $n_D[k]$  is the noise at the destination.

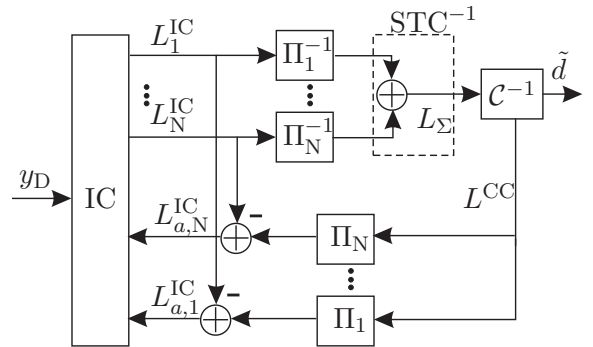

Fig. 2. Block diagram of the IDM-STC detector

The signals from different relays have to be separated at the destination with an iterative detection algorithm similar to an IDMA system. The block diagram of the iterative detection is shown in Figure 2. After soft interference cancellation, the resulting Log-Likelihood Ratios (LLRs)  $L_\nu^{IC}[k']$  are deinterleaved. To exploit the fact that all relays

have transmitted an estimate of the same code bit  $b$ , the IDM-STC over the relays is interpreted as a repetition code in space domain. Therefore, decoding the Space-Time Code, denoted as  $\text{STC}^{-1}$  in Figure 2, requires to sum up all deinterleaved LLRs  $L_\nu^{\text{IC}}[\Pi_\nu^{-1}(k')]$  before channel decoding

$$L_\Sigma[k'] = \sum_{\nu=1}^N L_\nu^{\text{IC}}[\Pi_\nu^{-1}(k')], \quad k' = 1, \dots, N_b. \quad (4)$$

$L_\Sigma[k']$  denotes the overall LLR of code bit  $b[k']$  which is fed to the decoder. This operation is similar to Maximum Ratio Combining (MRC). After reinterleaving, the LLRs  $L_\nu^{\text{IC}}[k']$  are subtracted from  $L^{\text{CC}}[k']$  to generate a-priori LLRs  $L_{a,\nu}^{\text{IC}}[k']$  for the interference canceler in the next iteration.

### B. Orthogonal Frequency Division Multiple Access with Cyclic Delay Diversity

Contrarily to the IDM-STC system, the description of the OFDM-CDD system is carried out in the frequency domain due to better readability. The source generates a sequence of OFDM symbols  $\mathbf{x}_S[i]$  by a  $N_c$ -point *inverse discrete fourier transformation* (IDFT). Additionally, a cyclic prefix of length  $N_g$  is inserted to cope with intersymbol interference due to multipath fading.

Each OFDM symbol  $\mathbf{x}_S[i]$  consist of  $N_c$  subcarriers with a signal to noise ratio on the  $\mu$ -th subcarrier of

$$\gamma_\nu[\mu] = \frac{|H_\nu[\mu]|^2 \cdot \sigma_x^2}{\sigma_N^2}, \quad (5)$$

since the noise  $\mathbf{n}_\nu[i]$  has zero mean and the covariance matrices for all links are assumed to be identical  $\hat{\mathbf{R}}_{\text{NN}} = \sigma_N^2 \mathbf{I}$ . In (5), the diagonal channel matrix  $\mathbf{H}_\nu = \text{diag}\{\text{FFT}\{\mathbf{h}_\nu\}\}$  between the source and relay  $\nu$ ,  $1 \leq \nu \leq N$  is given by the  $N_c$  point *discrete fourier transformation* (DFT) of the channel impulse response  $\mathbf{h}_\nu$ .

Given the diagonal channel matrix  $\mathbf{H}_\nu$  for the first hop, the received OFDM symbol for relay  $\nu$  can be described by

$$\mathbf{y}_\nu[i] = \mathbf{H}_\nu \mathbf{x}_S[i] + \mathbf{n}_\nu[i], \quad (6)$$

with time index  $i$ ,  $1 \leq i \leq N_s/N_c$ .

In order to forward the received signals to the destination in the second time slot, the relays remove the cyclic prefix and apply *cyclic delay diversity* (CDD) [8] and [9]

$$\mathbf{x}_\nu[i] = p_\nu \mathbf{C}_{\text{DD},\nu} \mathbf{y}_\nu[i]. \quad (7)$$

The cyclic delay diversity is simply applied in the time domain with a cyclic shift of the received OFDM symbols as seen in Figure 3. This cyclic shift is a subcarrier wise phase rotation of  $2\pi\delta_\nu\mu/N_c$  on subcarrier  $\mu$  in the frequency domain with the diagonal matrix

$$\mathbf{C}_{\text{DD},\nu} = \text{diag}\left\{e^{-\frac{j2\pi}{N_c} \cdot 1 \cdot \delta_\nu}, \dots, e^{-\frac{j2\pi}{N_c} \cdot N_c \cdot \delta_\nu}\right\}. \quad (8)$$

Here, each relay will choose a random shift  $\delta_\nu$  of the signal. Afterwards a new cyclic prefix has to be added.

The power normalization factor  $p_\nu$  in (7) ensures that the relays' transmit sequences have unit mean power.

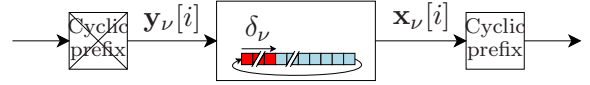

Fig. 3. Block diagram of relay  $\nu$  for OFDM-CDD

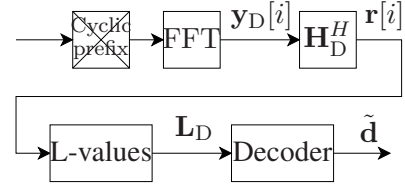

Fig. 4. Block diagram of the destination for OFDM-CDD

Assuming a synchronous transmission to the destination in Figure 4, the signals from the relays will superimpose together with a Gaussian distributed noise term  $\mathbf{n}_D[i]$ , with zero mean and variance  $\sigma_N^2$ , leading to

$$\begin{aligned} \mathbf{y}_D[i] &= \sum_{\nu=1}^N \mathbf{G}_\nu \mathbf{x}_\nu[i] + \mathbf{n}_D[i] \\ &= \mathbf{H}_D \mathbf{x}_S[i] + \tilde{\mathbf{n}}_D[i]. \end{aligned} \quad (9)$$

In (9),  $\mathbf{G}_\nu = \text{diag}\{\text{FFT}\{\mathbf{g}_\nu\}\}$  is the second-hop channel matrix from relay  $\nu$  to the destination. Moreover, the overall channel matrix  $\mathbf{H}_D$  is composed of the cyclic delay matrix, the power normalization at the relays and the channel matrices of both hops. Hence,  $\mathbf{H}_D$  is a diagonal matrix which can be described by

$$\mathbf{H}_D = \sum_{\nu=1}^N p_\nu \mathbf{G}_\nu \mathbf{C}_{\text{DD},\nu} \mathbf{H}_\nu. \quad (10)$$

The overall noise term  $\tilde{\mathbf{n}}_D$  including the forwarded noise from the first hops is as well given by

$$\tilde{\mathbf{n}}_D[i] = \sum_{\nu=1}^N p_\nu \mathbf{G}_\nu \mathbf{C}_{\text{DD},\nu} \mathbf{n}_\nu[i] + \mathbf{n}_D[i], \quad (11)$$

with the corresponding diagonal covariance matrix

$$\mathbf{R}_{\text{NN}} = \sigma_{\text{N}}^2 \cdot \left[ \sum_{\nu=1}^N p_{\nu}^2 \mathbf{G}_{\nu} \mathbf{G}_{\nu}^H + \mathbf{I} \right]. \quad (12)$$

After *matched filtering* at the destination with the Hermitian channel matrix  $\mathbf{H}_{\text{D}}^H$

$$\mathbf{r}[i] = \mathbf{H}_{\text{D}}^H \mathbf{H}_{\text{D}} \mathbf{x}_{\text{S}}[i] + \mathbf{H}_{\text{D}}^H \tilde{\mathbf{n}}_{\text{D}}[i],$$

the equalized signal  $\mathbf{r}[i]$  is multiplied with the inverse covariance matrix  $\mathbf{R}_{\text{NN}}^{-1}$  in order to generate  $L$ -values  $\mathbf{L}_{\text{D}}$  at the decoder input.

### III. PERFORMANCE COMPARISON

For the performance comparison we consider a 2-hop system with parallel relays without direct transmission from the source to the destination. Four relays are located in the middle between source and destination and the path loss exponent is set to 3; in the case of Rayleigh fading, all channel coefficients are iid. In order to show the diversity gain introduced

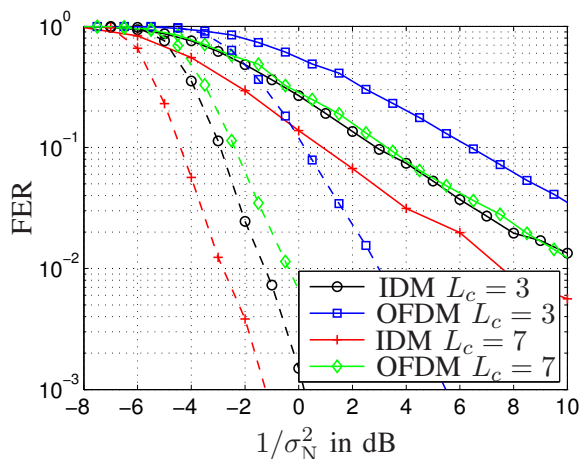

Fig. 5. Frame Error Rate in a network with 4 relays, 1st hop AWGN (- -) or Rayleigh fading (-)

by the relays of both schemes, we consider first a system with flat block Rayleigh fading on the second hop and either flat Rayleigh fading or AWGN channels on the first hop. The convolutional code has rate  $1/2$  and the constraint length is either 3 or 7. Furthermore, we assume uncorrelated block fading channels between the stations, i.e. the channels may not change during the transmission of one block consisting of 1024 code bits. For the OFDM-CDD system the number of subcarriers is  $N_c = 64$  and the guard length is fixed to  $N_g = 8$  leading to an SNR-loss of  $\approx 0.5$  dB which is considered in all simulation results. For the IDM-STC scheme 10 iterations are applied at the destination and the relays use random interleavers.

In Figure 5 the frame error rates (FER) are shown for OFDM-CDD and IDM-STC. It can be observed that IDM-STC clearly outperforms OFDM-CDD in all cases because if the iterative detection converges to the single user bound, optimal Maximum Ratio Combining (MRC) of all signal components is performed. The OFDM system decodes over subcarriers with different SNR values enabling diversity but suffering from an SNR loss. For the code with  $L_c = 3$  IDM-STC gains up to 4 dB and for  $L_c = 7$  the difference is  $\approx 2.5$  dB.

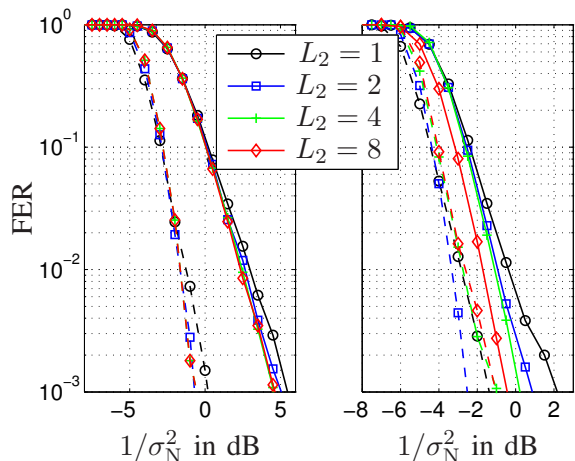

Fig. 6. Frame Error Rate in a network with 4 relays with IDM-STC (- -) and OFDM-CDD (-), 1st hop AWGN and second hop Rayleigh fading channels of different length, convolutional code with  $L_c = 3$  (left) and  $L_c = 7$  (right)

Now the system is generalized to frequency-selective fading on the second hop but still a flat channel on the first hop. It can be observed in Figure 6 that this additional diversity of the channel does not improve the performance significantly neither for IDM-STC nor for OFDM-CDD because there is already spatial diversity in the system. It can be shown, that the receiver SNR is quite robust against fading on the second hop as the effective SNR is dominated by the forwarded relay noise. The loss of OFDM compared to IDM-STC gets much smaller for the code with  $L_c = 7$  as OFDM benefits from stronger codes not only in terms of coding gain, but also in terms of exploiting diversity. Additionally it can be seen that IDM-STC may even suffer from longer channel impulse responses as too much interference degrades the iterative detection.

The situation changes if the first hop is frequency-selective. From Figure 7 the additional diversity due to increasing channel length becomes obvious which is exploited especially by the OFDM system. A variation of the SNRs on the first hop has a much stronger influence on the effective receiver SNR

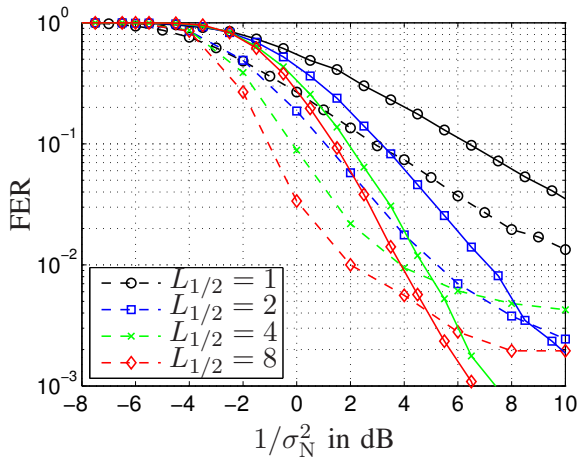

Fig. 7. Frame Error Rate in a network with 4 relays with IDM-STC (- -) and OFDM-CDD (-), both hops Rayleigh fading of different length, convolutional code with  $L_c = 3$

than the second hop. Again the specific behavior of relays applying AF is the reason for these effects. Another important observation here is the error floor for IDM-STC when the length of each channel increases. Up to a length of 2 the detector delivers sufficient results but for a length of 4 or even 8 the iterative detection fails sometimes even for high SNR. This effect can be explained by the convergence behaviour of IDM receiver. The input SINR and the interleaver size restrict the convergence of the iterative detection. When the input SINR gets smaller for long channel impulse responses the small interleaver size degrades the performance significantly. This effect gets even worse for stronger codes as can be seen in Figure 8 for a convolutional code with constraint length 7.

In contrast to this the OFDM-CDD approach gains

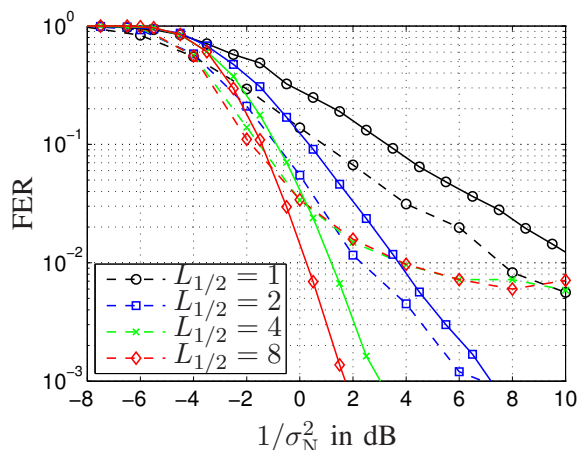

Fig. 8. Frame Error Rate in a network with 4 relays with IDM-STC (- -) and OFDM-CDD (-), both hops Rayleigh fading of different length, convolutional code with  $L_c = 7$

from the additional diversity and the performance

gets better the longer the channel impulse responses are. If the channel is longer than 2 taps, OFDM-CDD clearly outperforms IDM-STC for high SNR.

#### IV. CONCLUSION

In this paper two different approaches were considered to exploit diversity in relay networks: Distributed IDM Space-Time Codes and OFDM with cyclic delay diversity. As they differ in the way of utilizing diversity, the results strongly depend on the system parameters. IDM-STC is superior for flat channels as it applies Maximum Ratio Combining at the destination. OFDM-CDD gains more from frequency-selective channels on the first hop and therefore outperforms IDM-STC for high SNR especially when the constraint length of the channel code increases. Furthermore, the complexity of IDM-STC increases for larger channel memories and increasing number of iterations, whereas OFDM is known to be quite efficient. In summary, both schemes are able to exploit the spatial diversity provided by the relays, but their overall performance strongly depend on the channel conditions.

#### REFERENCES

- [1] W.K. Leung, K.Y. Wu, and L. Ping, "Interleave-Division-Multiplexing Space-Time Codes," in *IEEE Vehicular Technology Conference*, Jeju, Korea, Apr. 2003.
- [2] K.Y. Wu and L. Ping, "A Quasi-Random Approach to Space-Time Codes," *IEEE Transactions on Information Theory*, vol. 54, no. 3, pp. 1073–1085, Mar. 2008.
- [3] L. Ping, L. Liu, K. Y. Wu, and W. K. Leung, "Interleave Division Multiple Access," *IEEE Transactions on Wireless Communications*, vol. 5, no. 4, pp. 938–947, Apr. 2006.
- [4] Z. Fang, L. Li, and Z. Wang, "An Interleaver-Based Asynchronous Cooperative Diversity Scheme for Wireless Relay Networks," in *IEEE International Conference on Communications*, Beijing, China, May 2008.
- [5] P. Weitkemper, D. Wübben, and K.-D. Kammeyer, "Distributed Interleave-Division Multiplexing Space-Time Codes for Coded Relay Networks," in *Sixth International Symposium on Wireless Communication Systems*, Siena, Italy, Sept. 2009.
- [6] S. Kaiser, "Spatial transmit diversity techniques for broadband OFDM systems," in *IEEE Global Telecommunications Conference*, San Francisco, USA, Nov. 2000.
- [7] J.N. Laneman, D.N.C. Tse, and G.W. Wornell, "Cooperative Diversity in Wireless Networks: Efficient Protocols and Outage Behaviour," *IEEE Transactions on Information Theory*, vol. 50, no. 12, pp. 3062–3080, Dec. 2004.
- [8] S. Vorköper and V. Kühn, "Reducing the Channel Estimation Error for Relay Networks with Cyclic Delay Diversity," in *European Wireless Conference*, Aalborg, Denmark, May 2009.
- [9] S. Ben Slimane and A. Osseiran, "Relay Communication with Delay Diversity for Future Communication Systems," in *IEEE Vehicular Technology Conference*, Montreal, Canada, Sept. 2006.